

PACKAGE CONTENTS

- 1x Monit Brake Dial
- 1x Inner and outer cable – 1500mm long.
- 5x Cable clamps
- 2x Direction indication labels.
- 2x Balance bar to cable adaptors (7/16" and 3/8" threads)
- 2x Jam nuts (7/16" and 3/8" threads)
- 1x T5 Torx screwdriver

Bulkhead Mount model additional parts:

- 1x M20 black mounting nut
- 1x M2 Cheese head anti-rotation fastener

Square Mount model additional parts:

- 4x M4 Black stainless cap screws and lock nuts.

Important Information

- The Monit brake dial is designed for motorsport use. It should be installed by a competent technician and only used by suitably experienced race or rally drivers.
- It is up to the vehicle crew/driver to ensure the brake bias of the vehicle is correctly set at all times. Brake bias performance should be tested and checked prior to any critical braking situations.
- Ensure the balance bar and/or pedal box manufacturer's instructions are followed regarding assembly and operation of their products.

monit

Patent Pending

Monit Brake Dial Installation and User Guide

MOUNT INSTALLATION TEMPLATES

Bulkhead mounting type

There is an anti-rotate fastener (M2 "cheesehead") supplied in the parts bag. This can be screwed into the free M2 thread on the back of the Brake Dial mounting base, if required, to help prevent rotation of the dial when tightening the retaining nut.

1. Mark out the centre hole, and the hole for the anti-rotate fastener (if required) using the template dimensions shown below.
2. Drill holes and locate the dial in place. Tighten the bulkhead black M20 retaining nut finger tight initially ensuring the anti-rotate screw is located into the drilled hole.
3. Once correct, continue to tighten the retaining nut to a sufficient torque, this will vary depending on material it is binding to.

BULKHEAD TEMPLATE 1:1

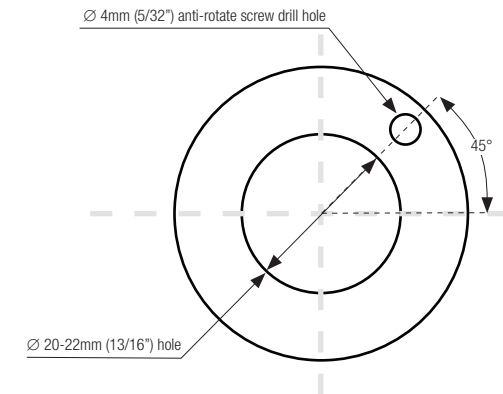

Battery Replacement

Note: The CR2032 coin cell battery life is approximately 18 months in normally operating conditions. It should be replaced when the battery icon stays on.

- Unscrew the 2x front face screws using the T5 torx screwdriver but leave approximately 1 – 1.5 turns of the screw still threaded into the front face part only. These screws can now be used to lift the front face out. There should be no resistance to the removing of this part, if there is then please unscrew the screws further until the resistance is removed.

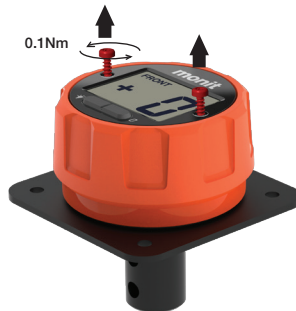

- Replace the CR2032 battery in the correct +/- orientation.
- When reassembling take care to not over tighten the screws as this will damage the threads. Recommended tightening torque is 0.1 Nm.

Square mounting type

1. Mark out the centre hole as well as the 4 mounting screw holes using the template dimensions shown.
2. Drill holes and locate the dial in place, Fix using the supplied 4x M4 black stainless cap screws and locknuts.

SQUARE MOUNT TEMPLATE 1:1

4 x \varnothing 3.5mm (9/64") hole

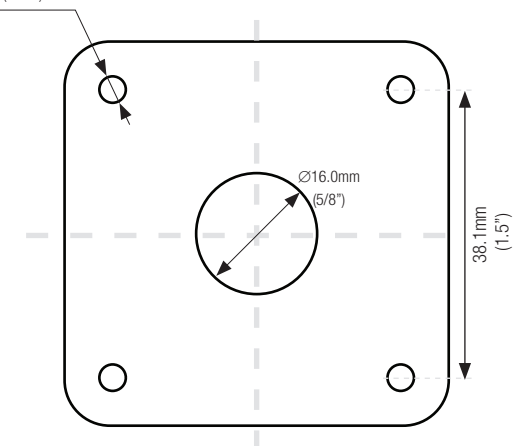



Monit Ltd
PO Box 4309,
Mount Maunganui 3149,
New Zealand.
www.monitmotorsport.com

SETUP MODE

Prior to entering setup mode of the Monit Brake Dial:

- Decide whether to view the Brake Bias dial setting relative to the; **FRONT**, or the **REAR**, or to view in **ABSOLUTE**. This decision is down to driver preference. It is recommended to view relative to **FRONT** if the driver preference is unknown/unsure.
- Check and determine if the front braking force is increased when the vehicles balance bar is rotated clockwise. Whether it increases or it decreases will be determined by the vehicles physical pedal box/balance bar layout relative to the brake master cylinders. This information will be used in Step 3 below

- 1 Press and hold down both the  and " buttons for 5 seconds. This will change to Set-up Mode and display the " (Clockwise) abbreviation. (The Brake Dial will return to operation mode if no buttons are pressed after 30 seconds)



Press and hold for 5 seconds



- 2 Pressing the " button will toggle between FRONT, REAR, and Absolute display options. Ensure this preference is chosen prior to Step 3.



FRONT DISPLAY

REAR DISPLAY

ABSOLUTE DISPLAY



- 3 Pressing the  button will toggle between " and ". This setting determines what turning the dial clockwise will indicate.



Press

Set to " the display will make a positive increment (+1) with each clockwise $\frac{1}{4}$ turn.

Set to " the display will make a negative change (-1 from the displayed count) with each clockwise $\frac{1}{4}$ turn.

- 4 Once preferred options have been set, hold down  and " for 3 seconds to save these settings and return to Operation Mode.

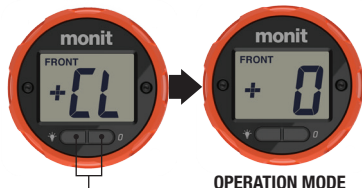



Press and hold for 3 seconds

OPERATION MODE

OPERATION MODE



Short Press of the  button will illuminate the display screen for 5 seconds

Long Press (2.5 seconds) the " button will reset the count to zero



Rotation of the dial will change the count displayed with reference to the settings saved.

Long Press (5 seconds) of the  button will toggle between 'A' and 'B' driver zero settings. The 'B' driver count is separate and can be zeroed independently to the main driver zero setting.

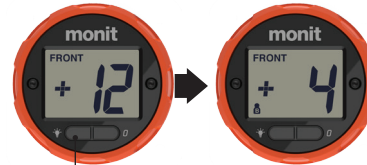

Press and hold for 5 seconds

CABLE INSTALLATION

Note: It is possible to use an existing cable and adaptor setup to connect the Brake Dial to the balance bar if the diameter of the cable is less than $\varnothing 3.95\text{mm}$. If using the existing cable, ensure there is sufficient cable inner exposed to locate and secure into the rear cable hole on the Monit Brake Dial.

- Choose a suitable location for mounting the Brake Dial. Trial fit the cable routing from this location to the balance bar on the brake pedal to point out any potential obstructions.

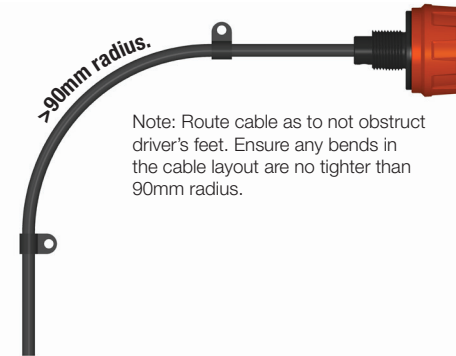

Note: Route cable as to not obstruct driver's feet. Ensure any bends in the cable layout are no tighter than 90mm radius.

- For optimum performance it is recommended to have fewer and larger bends in the cable with the shortest most direct route from dial to balance bar.
- Based on the routing the cable length may need to be shortened. With the cable in position mark where it needs to be cut. Remove assembly from the vehicle onto a workbench for cutting. Braze the inner cable at the cut mark to avoid fraying when cutting. (Remove the inner cable from the outer cable to avoid melting).
- Cut the cable outer 20mm shorter than the finished inner cable length.
- Once the mounting location and cable routing has been determined, fix the cable to your vehicle using the cable clamps supplied. To ensure optimum performance of the cable and dial ensure to use all the clamps provided.
- Insert the cable inner into the appropriate balance bar adaptor (3/8" or 7/16" depending on balance bar thread) and secure by tightening the M4 grub screw to a recommended torque of 0.5-1.0Nm. Use this same torque setting for the end of the cable that is inserted into the back of the Brake Dial.
- Secure the balance bar adaptor by tightening the jam nut against it to the recommended torque settings from your balance bar manufacturer.
- Observe the effect that rotating the dial clockwise has on the brake rotation and apply the relevant rotation direction label to reflect this.

