



**PLUG 'N' PLAY ADAPTER HARNESS
FOR NEXUS S2/S3 ECU**

SUPPORTED MODELS:

Honda Civic EP3 MY02-05

Honda Integra DC5 MY02-04

Acura RSX MY02-04

QUICK START GUIDE

HT-186343



9 356450 015301

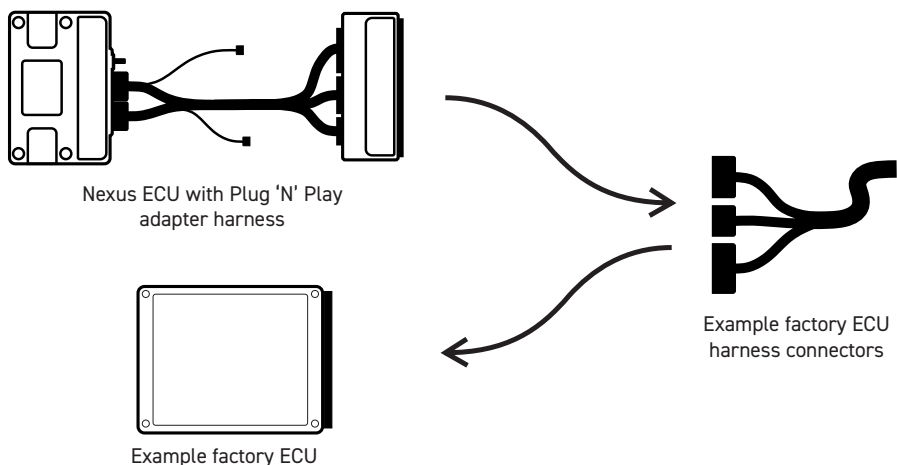

Congratulations on your purchase of a Nexus Plug 'N' Play adapter harness for your vehicle. This vehicle-specific adapter harness enables you to seamlessly integrate a Nexus S2 or S3 ECU into your vehicle without the complexities of wiring an ECU. With this hassle-free solution, you can dive straight into tuning.

Nexus ECUs stand at the forefront of engine management systems, featuring cutting-edge technology and innovative features. Designed for

the next generation of automotive enthusiasts and professionals, this state-of-the-art ECU seamlessly combines powerful engine control with a range of additional functionalities, making it a versatile and comprehensive solution for everyday driving to high-performance racing.

With full compatibility with a myriad of Haltech devices, it streamlines the configuration of engine parameters and additional functionalities, all programmable using a single piece of software.

What's in the box?

- HT-186343 - Honda Civic EP3 MY02-05 Nexus Plug 'N' Play adapter box
- HT-130400 - Nexus S2/S3 Plug 'N' Play adapter harness
- HT-010200 - Intake air temperature sensor (M14 x 1.5 thread)
- Quick Start Guide

Application Notes

- This Honda Civic EP3 MY02-05 Nexus Plug 'N' Play adapter harness is designed to be optimally used with a Nexus S3 ECU. Using a Nexus S2 will reduce some of the car's factory functionality. These functions are labeled "S3 only" and can be checked in the pinout reference tables found in the last few pages of this quick start guide.

- Ensure that the correct basemap is uploaded into the ECU before powering the unit through the Plug 'N' Play adapter harness.

- Please note that the basemap serves as a starting point only, and the ECU will require appropriate tuning. Haltech will not be held responsible for engine damage due to the improper use of basemaps.

- Multiplex Control Unit notes - This adapter harness does not support the OEM Multiplex Control Unit communication signals used by the vehicle. Therefore, the following OEM functionalities are not available:

- Coolant temperature display on OEM dash
- Battery light display on OEM dash
- A/C request signal from Multiplex Control Unit

A spare AVI input is available on the auxiliary connector to wire in an A/C request signal from the A/C pressure switch / Heater control panel to support the Air Conditioner functionality if required..



Uploading the correct basemap

Your Nexus ECU can communicate with a laptop in low power mode using just a USB cable connection. This feature enables you to upload the basemap without powering the ECU through the Plug 'N' Play adapter harness. This ensures that all the ECU inputs and outputs are configured specifically for your engine before powering the vehicle up.

To upload the correct basemap into your Nexus ECU, follow these general steps:

1. Install/Open Haltech NSP: Haltech Nexus Software Programmer (NSP) is the software tool for configuring and tuning your Nexus ECU. Download

and install NSP from the Haltech website to your Windows laptop if you haven't already done so. Instructions on how to install the software are available in the quick start guide that came with your Nexus ECU.

2. Connect to the ECU: Use the included USB-A to USB-C interface cable to connect your laptop to the Nexus ECU.

3. Upload the Basemap: Once connected, initiate the upload process by clicking on the File Menu, then click on Import/Upload, then navigate to the Haltech basemaps folder. Typically, this will be in Documents > Haltech > Nexus Maps and Data Logs > Base Maps. Choose the correct basemap file for your application as shown in the next page, then click Open.

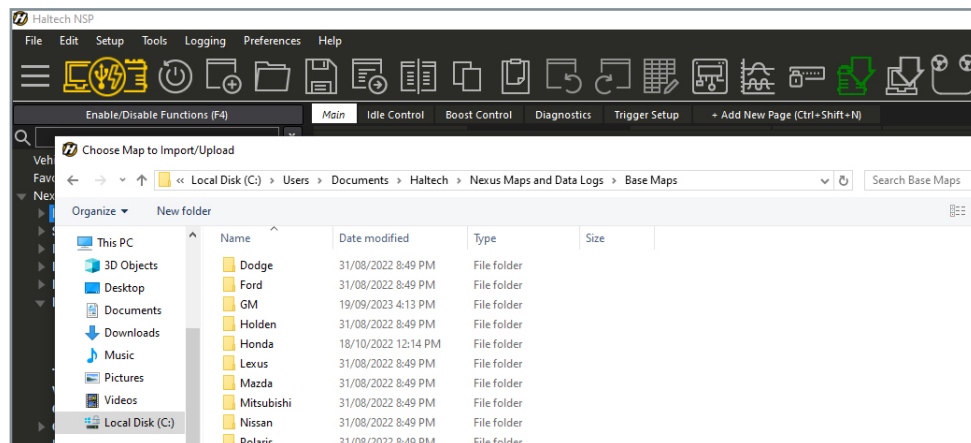
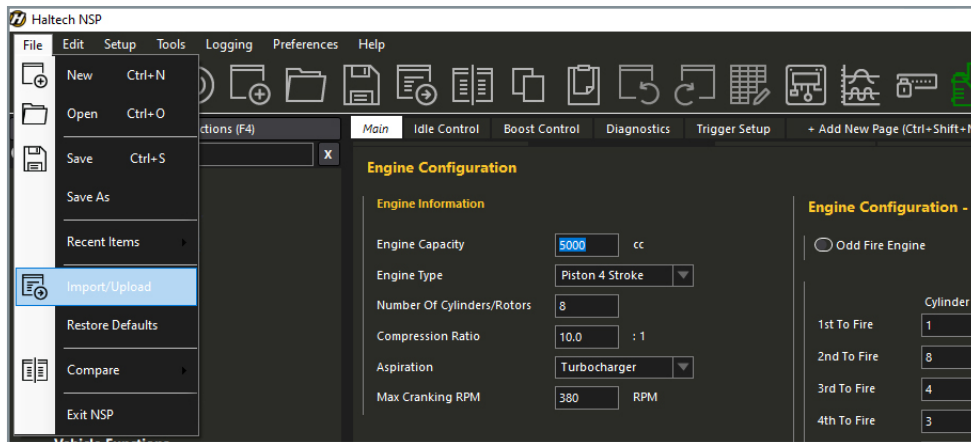

4. Upload All Settings: After opening the file, the NSP software will give you the option to upload specific parts of the map or to upload all the settings. Click on "Upload All" to copy all the base settings to your Nexus ECU. After NSP writes all the settings, click on the Reboot button to reinitialize the ECU.

5. Configure Application-Specific Settings: If you are using non-standard components on your engine, you will need to reconfigure the Nexus ECU to suit before connecting the unit to the Plug 'N' Play adapter harness and powering up the vehicle. These

may include changing injector sizes/flow rates, adjusting ignition coil settings, or reconfiguring the trigger settings to match an aftermarket trigger kit.

6. Setup the Internal Jumpers: Some adapter boxes feature internal jumpers that you can set to suit specific vehicle models. If you need to change the jumper settings beyond the default configuration, open up the adapter box and follow the instructions provided in the previous section.

At this stage, the Nexus ECU and Plug 'N' Play harness are now ready to be installed into the vehicle for the initial start-up.

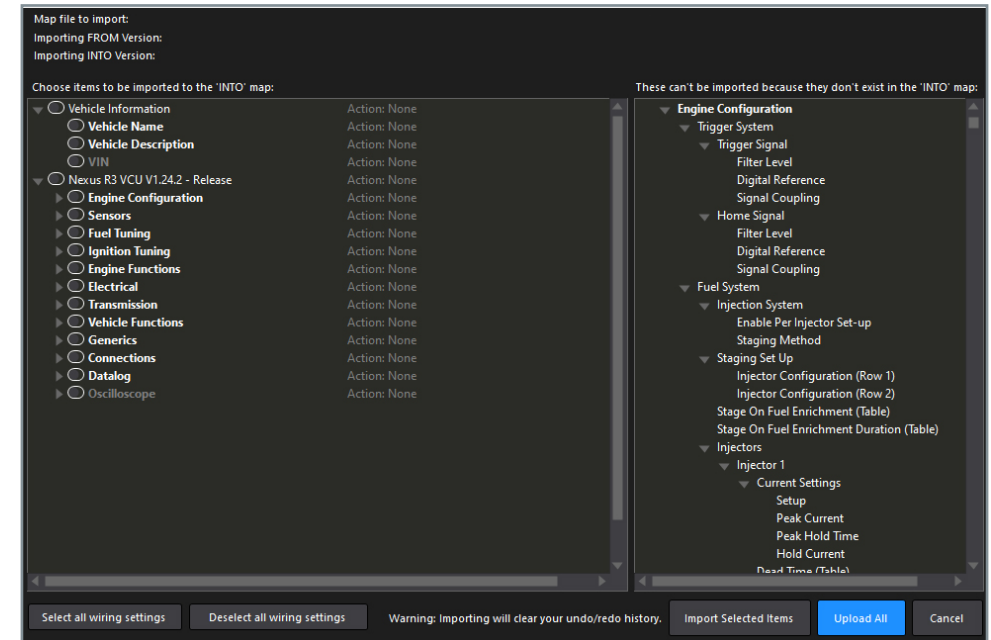

Wideband Oxygen Sensor

A Wideband Oxygen Sensor is a valuable tool for tuning your engine, as it measures a wide range of Air-Fuel Ratio (AFR) values that the engine operates within.

The Nexus S3 ECU supports onboard wideband oxygen sensor control, specifically designed for Bosch LSU 4.9 or NTK wideband sensors, which can be selected through the NSP software.

The adapter harness is equipped with a Deutsch DTM-6 connector, allowing direct connection to the Haltech Wideband Hardware packs shown below (sold separately).

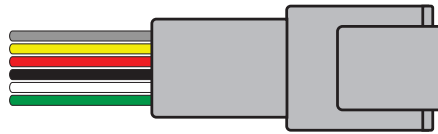

Wideband Connector (DTM04-6P)

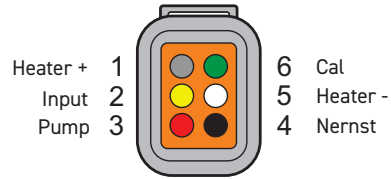

(Wire side view)

In addition to tuning, you can configure the Nexus ECU to adjust fueling to actively target the desired AFR (i.e. O2 control), or implement an engine protection strategy if the sensor detects that the engine is running too lean.



HT-010746 - Bosch LSU4.9 Wideband Hardware Pack



HT-010747 - NTK LZA08-H5 Wideband Hardware Pack

Haltech CAN System

The Nexus S3 ECU adapter harness is fitted with a DTM-4 CAN connector labelled as "CAN 1", which can be utilized with a range of Haltech CAN expansion products.

The diagram below illustrates example connections to multiple Haltech CAN devices (sold separately) or to a CAN WB1 / WB2 wideband module which requires external power.

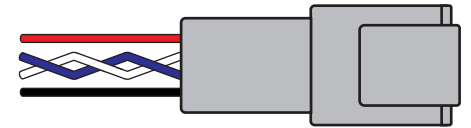

Haltech CAN 1 Connector (DTM04-4P)

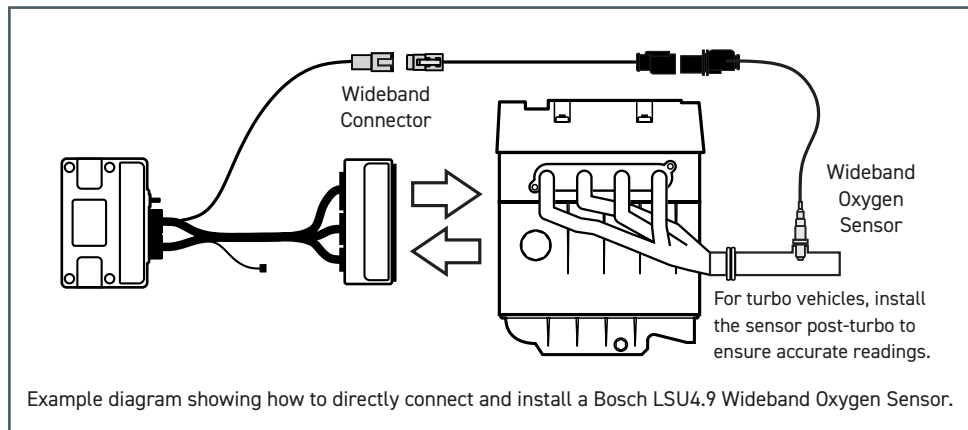
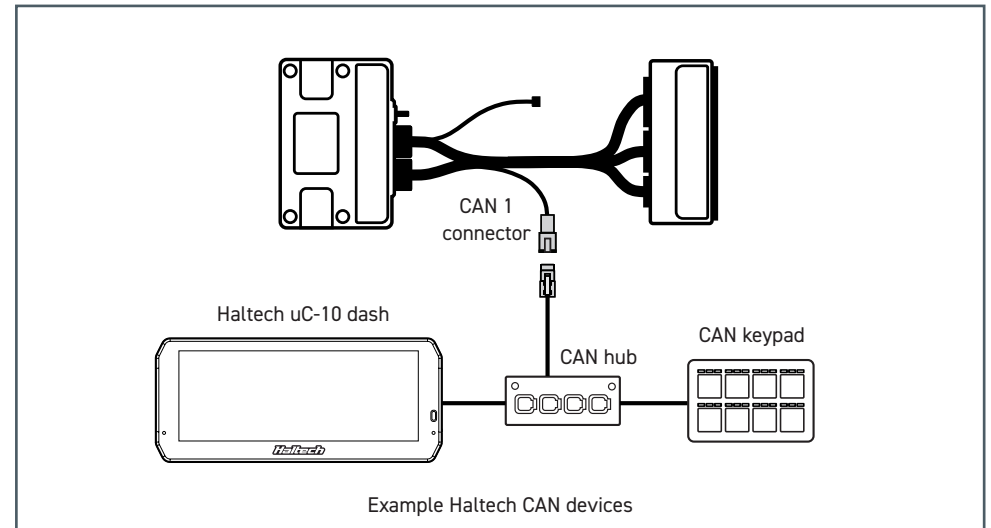
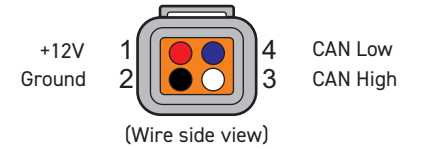

SENSORS AND ECU LOCATION

Air Temperature Sensor

An air temperature sensor is a crucial component used in Volumetric Efficiency (VE) tuning to compensate for changes in air density caused by temperature variations.



Cold air, being denser than warm air, requires more volume of fuel to maintain the same air-fuel ratio. With this information available, the Nexus ECU can automatically adjust fuel delivery based on temperature changes using the signal received from the air temperature sensor.

While many vehicles include a factory air temperature sensor, it is often located within the Mass Air Flow (MAF) sensor assembly or integrated into the intake air manifold. Typically, performance applications involve the removal of the MAF sensor or even changing the entire intake manifold. In such cases, an air temperature sensor (HT-010200) is provided as a replacement for the factory sensor.

Mounting the included sensor in the optimal position is crucial to accurately measure the air temperature entering the combustion chamber. Typically, a good location is just before the throttle body and after a turbocharger/intercooler if using forced induction. It's essential for the sensor to be in the moving air stream for rapid response times and to minimize heat soak effects. Caution must be exercised when mounting the sensor directly into the inlet manifold, especially at the rear, as this may lead to heat soak issues, where the sensor reads the manifold temperature rather than the air moving through it.

Once a suitable position is identified, a hole must be drilled and tapped to accommodate the sensor. A weld-on bung may also be used if necessary. It's recommended to remove the air intake pipe or relevant intake hardware when installing the sensor to prevent metal shavings from entering the engine.

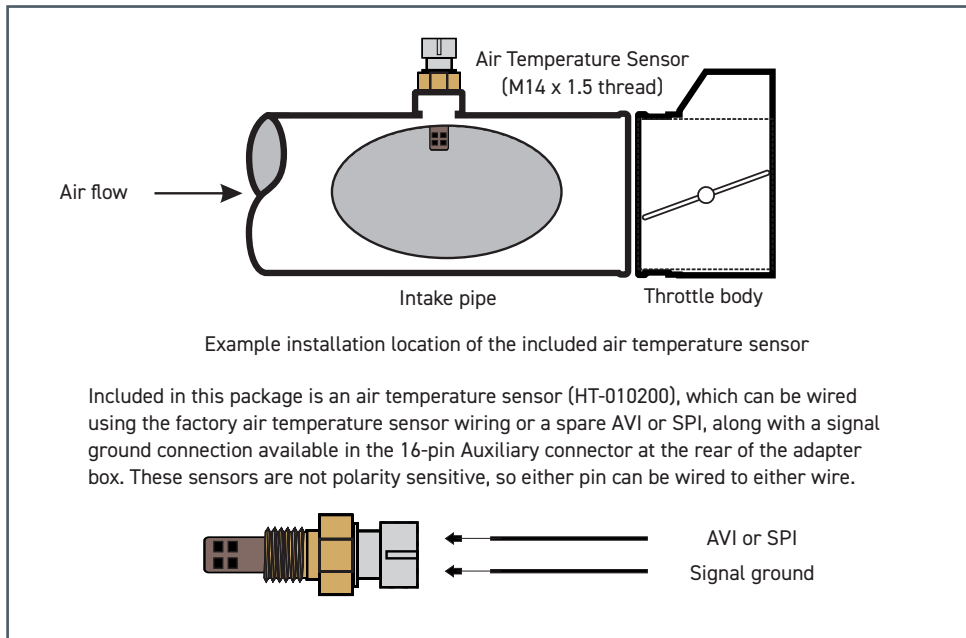

ECU Internal MAP Sensor (4 Bar)

The basemaps provided with this product will either utilize the factory MAP sensor, if the vehicle is equipped with one from the factory, or utilize the Nexus S3 ECU's Internal MAP sensor. You can check this in the software settings under Sensors > Manifold Pressure > Wiring > Input Type to see which one is being used.

If the ECU internal MAP sensor is selected, a vacuum hose must be connected from the ECU's MAP sensor barb to a vacuum port on the engine's

intake manifold. This onboard sensor is a 4 Bar MAP sensor capable of reading vacuum and boost pressures up to 43.5 psi. No user calibration is necessary for this sensor.

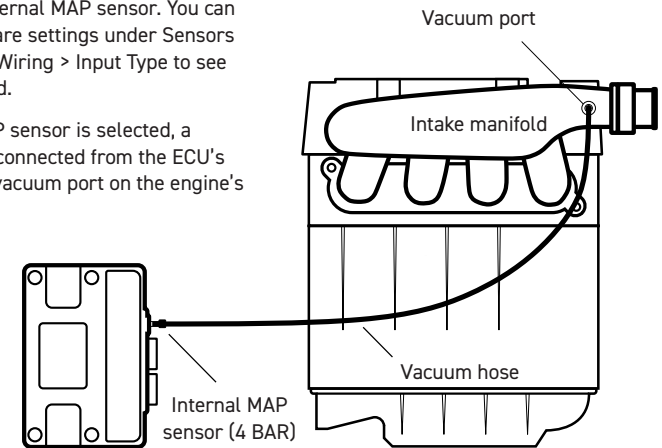

ECU location

The factory Honda Civic EP3 ECU is located behind the glove compartment. Removal of the glove compartment allows the installation of this Haltech Plug 'N Play product. Below is a generic illustration for reference.

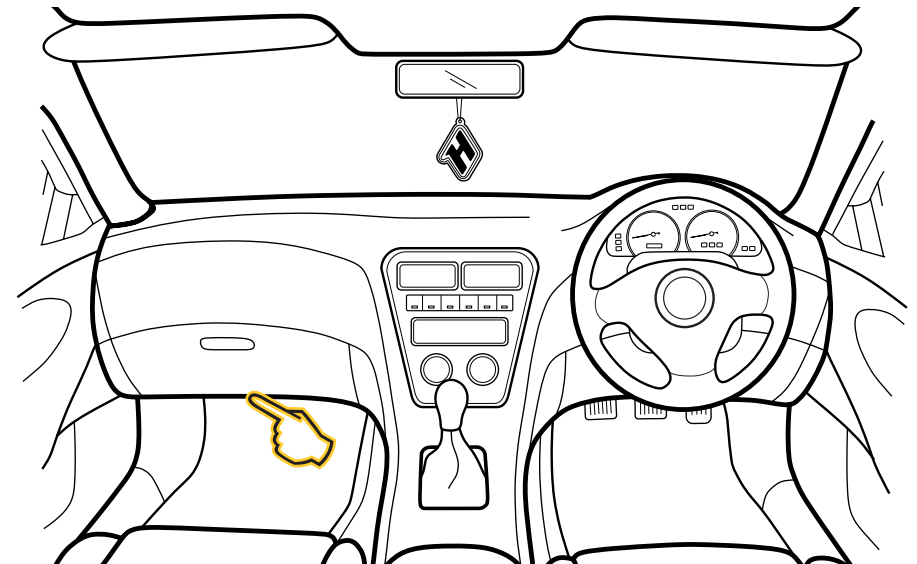

ADAPTER PINOUT REFERENCE

Vehicle connector:

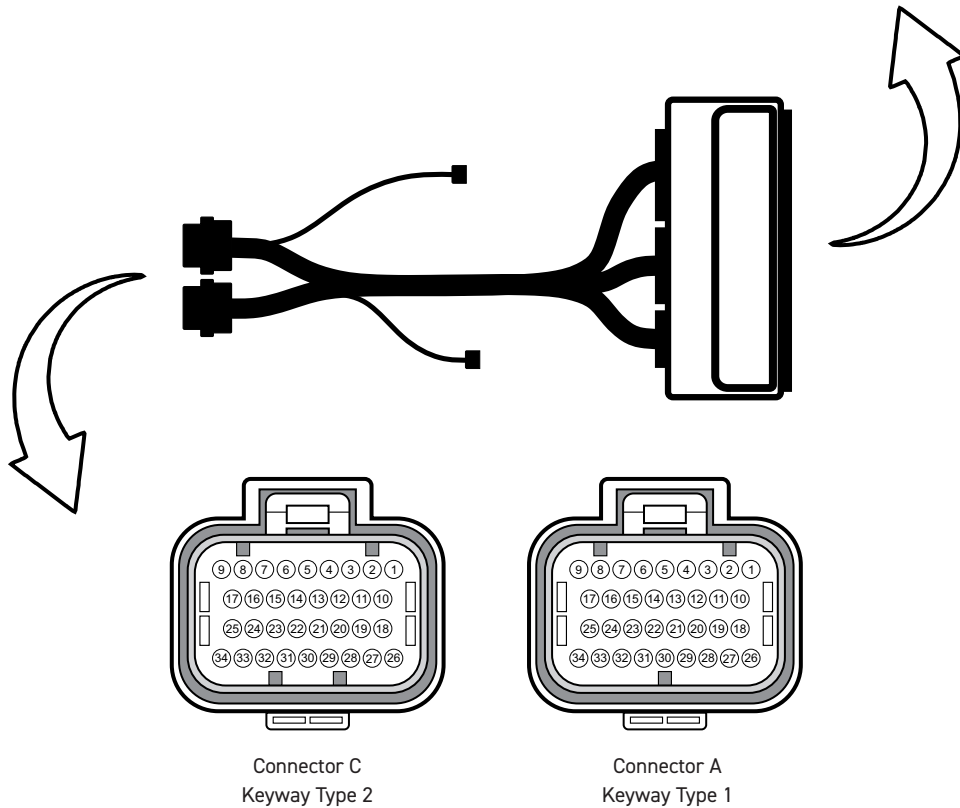
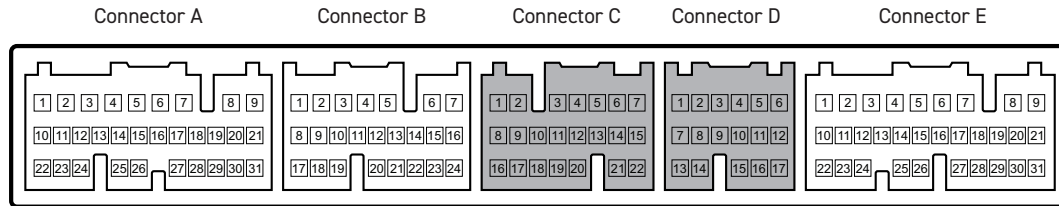

All connectors above are shown with reference to the pin side (front of connectors).

NEXUS S3/S2 ECU CONNECTOR A (KEYWAY TYPE 1)

Pin	Function	Colour	Vehicle connector	Function
A1	Injector 1	Blue	B5	Injector 1
A2	Injector 2	Blue/Black	B4	Injector 2
A3	Injector 3	Blue/Brown	B3	Injector 3
A4	Injector 4	Blue/Red	B2	Injector 4
A5	Injector 5 (S3 only)	Blue/Orange	No connection	No connection
A6	Injector 6 (S3 only)	Blue/Yellow	No connection	No connection
A7	Injector 7 (S3 only)	Blue/Green	B7	Reverse lockout solenoid
A8	Injector 8 (S3 only)	Blue/Violet	B18	Alternator control
A9	DPO 1	Violet/Black	E26	Tachometer
A10	Battery ground input	Black	No connection	Reserved for shield
A11	Battery ground input	Black	B23, A4, A5	Power ground
A12	DPO 2	Violet/Brown	A12	IACV
A13	Ignition switch input	Pink	E9	Ignition switch input
A14	DPO 3	Violet/Red	E18	A/C clutch
A15	DPO 4	Violet/Orange	E25	VSS output for dash
A16	DPO 5	Violet/Yellow	E1, E10	Fuel pump
A17	DPO 6	Violet/Green	B6	Thermofan
A18	+12V switched input	Red	A2, A3	+12V power from ECR
A19	HBO 1	Brown/Black	B22	Intake manifold runner
A20	HBO 2	Brown/Red	E31	Check engine light
A21	HBO 3	Brown/Green	B1	VTC +
A22	HBO 4	Brown/Pink	B15	VTEC solenoid +
A23	CAN 1 H	White	CAN connector Pin 3	Haltech CAN devices
A24	CAN 1 L	Blue	CAN connector Pin 4	(See page 7 for details)
A25	+12V switched input	Red	A2, A3	+12V power from ECR
A26	ECR output	Black/Red	E7	ECR
A27	Ignition 1	Yellow/Black	A30	Ignition 1
A28	Ignition 2	Yellow/Red	A29	Ignition 2
A29	Ignition 3	Yellow/Orange	A28	Ignition 3
A30	Ignition 4	Yellow/Green	A27	Ignition 4
A31	Ignition 5 (S3 only)	Yellow/Brown	E20	EVAP bypass solenoid
A32	Ignition 6 (S3 only)	Yellow/Blue	E21	EVAP vent shut valve
A33	Ignition 7 (S3 only)	Yellow/Violet	B21	EVAP purge valve
A34	Ignition 8 (S3 only)	Yellow/Gray	No connection	No connection

ADAPTER PINOUT REFERENCE

Vehicle connector:

Connector A Connector B Connector C Connector D Connector E

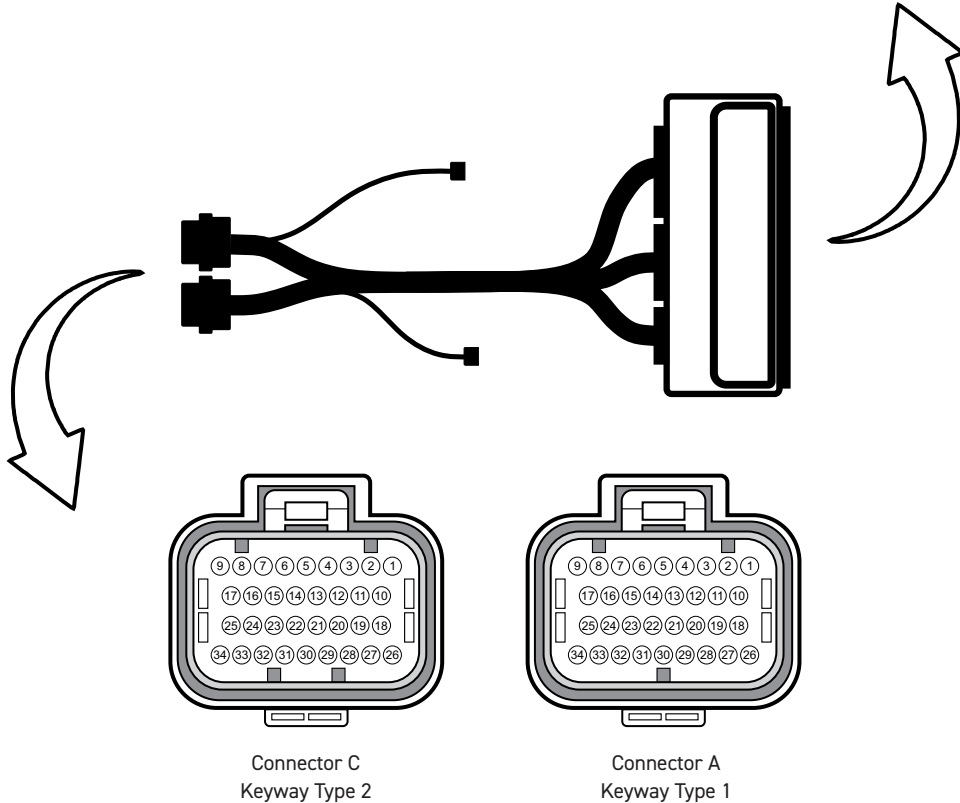
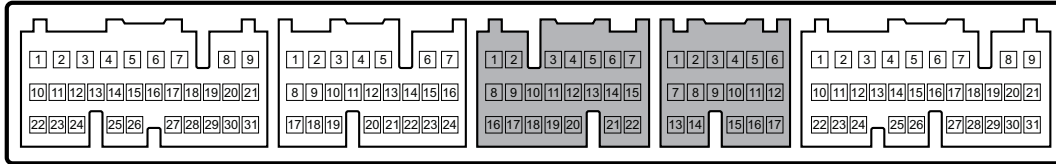

All connectors above are shown with reference to the pin side (front of connectors).

NEXUS S3/S2 ECU CONNECTOR C (KEYWAY TYPE 2)

Pin	Function	Colour	Vehicle connector	Function
C1	Trigger +	White	A7	Crank position sensor
C2	Trigger -	Black	No connection	No connection
C3	Home +	White	A26	TDC sensor
C4	Home -	Black	No connection	No connection
C5	SPI 1	Gray/Brown	To auxiliary connector	Auxiliary IO
C6	SPI 2	Gray/Red	A8	Intake runner position
C7	SPI 3	Gray/Orange	A18	Vehicle speed sensor
C8	SPI 4	Gray/Yellow	A25	Cam position sensor
C9	+8V	Orange/White	No connection	No connection
C10	AVI 1	White	B9	VTEC oil pressure switch
C11	AVI 2	White/Yellow	E16	Power steering switch
C12	AVI 3	White/Gray	E14	Fuel tank pressure
C13	AVI 4	White/Violet	E22	Brake switch
C14	AVI 5	White/Green	To auxiliary connector	Auxiliary IO
C15	AVI 6	White/Orange	E15	Electrical load detector
C16	AVI 7	White/Black	B17	Air temperature
C17	AVI 8	White/Brown	B8	Coolant temperature
C18	AVI 9	White/Red	A19	Manifold Pressure
C19	SPI 5	No connection	No connection	No connection
C20	SPI 6	No connection	No connection	No connection
C21	CAN 2 H	White	No connection	No connection
C22	CAN 2 L	Blue	No connection	No connection
C23	Knock 1	White	A9	Knock sensor
C24	Knock 2	White	No connection	No connection
C25	+5V	Orange	E5, A20, A21	Sensor power supply
C26	Signal ground	Black/White	E4, A10, A11, A23, A24	Sensor ground
C27	AVI 10	Light Green	A15	Throttle position sensor
C28	AVI 11	No connection	No connection	No connection
C29	WBI 1 Heater +	Gray	Wideband conn. Pin 1	Onboard wideband control (See page 6 for details)
C30	WBI 1 Input	Yellow	Wideband conn. Pin 2	
C31	WBI 1 Pump	Red	Wideband conn. Pin 3	
C32	WBI 1 Nernst	Black	Wideband conn. Pin 4	
C33	WBI 1 Heater -	White	Wideband conn. Pin 5	
C34	WBI 1 Cal	Green	Wideband conn. Pin 6	

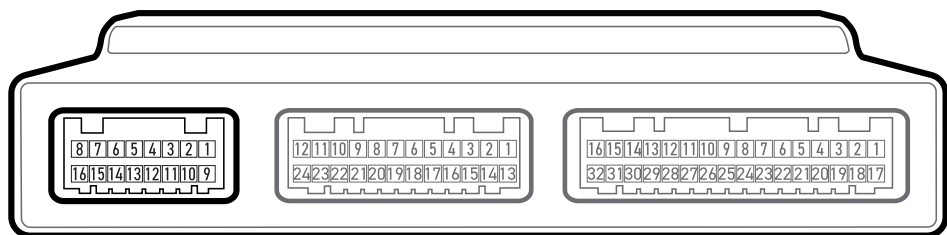

Auxiliary Connector

The 16-pin auxiliary connector located on the rear side of the adapter provides additional inputs and outputs that link to the Nexus ECU. The kit is supplied with spare pins that you can use if you need to connect to these additional I/Os. Use an appropriate crimping tool, such as the HT-070300.

Please refer to the pinout information below for details on the spare inputs and outputs available for this application.

AUXILIARY CONNECTOR (16 PIN)			
Pin	Connection	Function	Notes
1	From Nexus ECU (C25)	+5V	+5V DC sensor supply
2	From Nexus ECU (C14)	AVI 5	Spare input
3	No connection	No connection	No connection
4	From Nexus ECU (C26)	Signal ground	Signal ground for sensors
5*	From Nexus ECU (A33)	Ignition 7 (S3 only)	EVAP purge solenoid (Vehicle conn. B21)
6*	From Nexus ECU (A34)	Ignition 8 (S3 only)	Spare output
7	From Nexus ECU (C5)	SPI 1	Spare input
8	From Nexus ECU (A18/A25)	+12V	+12V DC switched supply for relays and solenoids
9	From Nexus ECU (C25)	+5V	+5V DC sensor supply
10	No connection	No connection	No connection
11	No connection	No connection	No connection
12	From Nexus ECU (C26)	Signal ground	Signal ground for sensors
13	No connection	No connection	No connection
14*	From Nexus ECU (A8)	Injector 8 (S3 only)	Alternator control (Vehicle conn. B18)
15	No connection	No connection	No connection
16	From Nexus ECU (A18/A25)	+12V	+12V DC switched supply for relays and solenoids

* These pins have a direct wired connection to the Nexus ECU. The rest of the pins on this auxiliary connector loop within the adapter box and back to the Nexus ECU through the 24- and 32-pin Tyco connectors.



WARRANTY CERTIFICATE

At Haltech we make every effort to design and manufacture fault-free products that perform up to or above the market expectations. All our products are covered by a Limited 12 Month Warranty.

Haltech Limited Warranty

Unless specified otherwise, Haltech warrants its products to be free from defects in material or workmanship for a period of 12 months from the date of purchase.

If the Haltech product is found to be defective as mentioned above, it will be replaced or repaired if returned prepaid along with proof of purchase. Proof of purchase in the form of a copy of the original purchase invoice, receipt or bill of sale which indicates that the product is within the warranty period, must be presented to obtain warranty service.

Replacement or repair of a defective product shall constitute the sole liability of Haltech. To the extent permitted by law, the foregoing is exclusive and in lieu of all other warranties or representations, either expressed or implied, including any implied warranty of merchantability or fitness. In no event shall Haltech, be liable for special or consequential damages.

Product Returns

Please include a copy of the original purchase invoice, receipt or bill of sale along with the unused, undamaged product and its original packaging. Any product returned with missing accessory items or packaging will incur extra charges to return the item to a re-saleable condition.

All product returns must be sent via a freight method with adequate tracking, insurance and proof of delivery services. Haltech will not be held responsible for product returns lost during transit.

Returns of Products Supplied in Sealed Packaging

The sale of any sensor or accessory supplied in sealed packaging is strictly non-refundable if the sealed packaging has been opened or tampered with. This will be clearly noted on the product packaging. If you do not accept these terms please return the sensor in its original unopened packaging within 30 days for a full refund.

A sensor or accessory product may be returned after 30 days of purchase (with its sealed packaging intact) for credit only (no refunds given) and will be subject to a 10% restocking fee.

Installation of Haltech Products

No responsibility whatsoever is accepted by Haltech for the fitment of Haltech Products. The onus is clearly on the installer to ensure that both their knowledge and the parts selected are correct for that particular application. Any damage to parts or consequential damage or costs resulting from the incorrect installation of Haltech products are totally the responsibility of the installer.

Always disconnect the battery when doing electrical work on your vehicle. Avoid sparks, open flames or use of electrical devices near flammable substances. Do not run the engine with a battery charger connected as this could damage the ECU and other electrical equipment.

Do not overcharge the battery or reverse the polarity of the battery or any charging unit. Disconnect the Haltech ECU from the electrical system whenever doing any welding on the vehicle by unplugging the wiring harness connector from the ECU.

After completing the ECU installation, make sure there is no wiring left un-insulated. Uninsulated wiring can cause sparks, short circuits and in some cases fire. Before attempting to run the engine ensure there are no leaks in the fuel system.

All fuel system components and wiring should be mounted away from heat sources, shielded if necessary and well ventilated. Always ensure that you follow workshop safety procedures. If you're working underneath a jacked-up car, always use safety stands!

Haltech Off-Road Usage Policy

In many states it is unlawful to tamper with your vehicle's emissions equipment. Haltech products are designed and sold for sanctioned off-road/competition non-emissions controlled vehicles only and may never be used on a public road or highway.

Using Haltech products for street/road use on public roads or highways is prohibited by law unless a specific regulatory exemption exists (more information can be found on the SEMA Action Network website www.semasan.com/emissions for state by state details in the USA).

It is the responsibility of the installer and/or user of this product to ensure compliance with all applicable local and federal laws and regulations. Please check with your local vehicle authority before purchasing, using or installing any Haltech product.



Haltech Australia

17 Durian Place,
Wetherill Park NSW 2164
Australia
Phone: +61 2 9729 0999
Email: aus@haltech.com

Haltech New Zealand

Grey Lynn Auckland, NZ 1021
Phone: 09 887 0616
Email: nz@haltech.com

Haltech USA East

750 Miles Point Way,
Lexington, KY USA 40510
Phone: (888) 298 8116
Email: usa@haltech.com

Haltech USA West

Race Winning Brands,
10800 Valley View Street,
Cypress, CA 90630
Phone: (888) 298 8116
Email: usa@haltech.com

Haltech UK

Unit 1, Miras Business Estate,
Keys Park Road, Hednesford,
WS12 2FS
Phone: +44 121 285 6650
Email: uk@haltech.com

Haltech Europe

Ottogasse 2A,
2333 Leopoldsdorf, Austria
Phone: +43 720 883968
Email: europe@haltech.com

